

PHILIPS MAGNAVOX

REM400 DSS Universal Remote Control



User's Guide

TABLE OF CONTENTS

Introduction	2	Operating Your Remote Control.	8
Keys And Functions	2	About Other Features	11
Setting Up Your Remote Control	3	Quick Features Setup Guide	12
About Batteries	4	Troubleshooting	14
Using The Lighted Keypad	4	Manufacturer's Codes.	15
Programming Your Remote Control.	5		

INTRODUCTION

The DSS Universal Remote Control is the complete solution for all of your DSS remote control needs. Specifically designed to operate the features of your DSS satellite system, it can be programmed to operate a variety of components, up to six at a time, and is packed with easy-to-use features such as:

- Fingertip navigation control of interactive DSS on-screen menus (see page 8).
- Auto Scan code search to help program remote control for a variety of components, including older/discontinued models.

- Channel Scan, a convenient way to “channel surf” by scanning channels.
- Multi-component Power Key for master on/off control of home entertainment components with a single key press.
- Favorite Command Keys that allow you to define and program a number of key presses into a sequence that can be accessed by a single key press.
- Learning capability to store and recall additional remote control functions.

KEYS AND FUNCTIONS

Use the illustration below to locate DSS keys and then study the numbered *Key Charts*

(on the next page) to learn how each one functions.

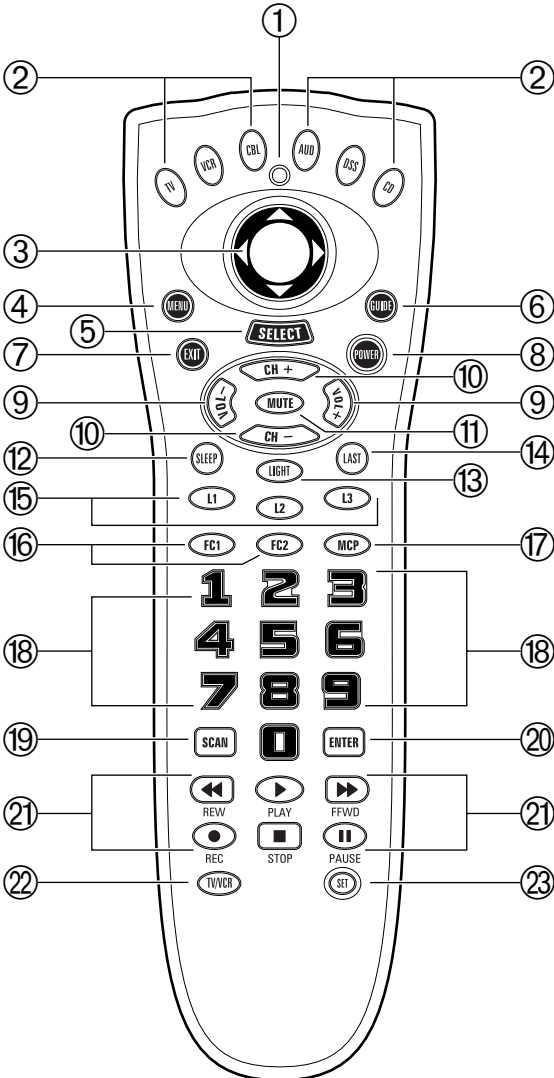

KEYS AND FUNCTIONS (continued)

Key Charts

- ① **Red Indicator Light**
The Red Indicator Light blinks to show that the remote control is working and also provides feedback during programming sequences.
- ② **Component Keys**
Press **TV**, **VCR**, **CBL**, **AUD**, **DSS**, or **CD** once to select a home entertainment component to control.
- ③ **DSS Directional Pad**
Use the pad to move the cursor in the program guide and menu screens.
- ④ **MENU Key**
Press **MENU** to access the menu of your chosen component.
- ⑤ **SELECT Key**
Use **SELECT** to choose options from your selected component's menu or guide.
- ⑥ **GUIDE Key**
Use **GUIDE** to display the programming guide for your components (if applicable).
- ⑦ **EXIT Key**
Use **EXIT** to exit out of the selected component's menu or guide.
- ⑧ **POWER Key**
Press **POWER** once to turn on or off the selected home entertainment component.
- ⑨ **VOL Keys**
Use **VOL +** (or **VOL -**) to raise (or lower) the sound volume.
- ⑩ **CH Keys**
Use **CH +** (or **CH -**) to select the next higher (or lower) channel for the selected home entertainment component.
- ⑪ **MUTE Key**
Press **MUTE** once to turn sound off or on.
- ⑫ **SLEEP Key**
Press **SLEEP** to activate your TV's internal sleep timer. (Not available for all TVs.)
- ⑬ **LIGHT Key**
Press **LIGHT** once to turn on or off the keypad back light.
- ⑭ **LAST Key**
Press **LAST** once to recall the last channel and to page back one screen in the main menu.
- ⑮ **L1~L3 Keys**
Use the learning keys, L1~L3, to store and recall additional remote control functions.
- ⑯ **FC1 And FC2 Keys**
User-programmable Favorite Command Keys (see page 9 for details).
- ⑰ **MCP Key**
Multiple-component On/Off Key (see page 9 for details).
- ⑱ **Keypad**
Use the keypad (**0~9**) to directly enter in channels (for example, 09 or 31). The keypad is also used for all programming sequences, such as entering in your programming codes.
- ⑲ **SCAN Key**
Press **SCAN** once to change channels every 3 seconds. Press it again to stop the scan.
- ⑳ **ENTER Key**
Press **ENTER** once after entering channel numbers on some TV models.
- ㉑ **VCR Transport Keys**
Use the VCR Transport Keys to control your VCR, as well as CD or DVD player. Press **REC** twice to record a tape.
- ㉒ **TV/VCR Key**
Press **TV/VCR** once to view VCR playback or TV through the VCR.
- ㉓ **SET Key**
Use **SET** for all programming sequences.

SETTING UP YOUR REMOTE CONTROL

Before using your new DSS remote control, you will need to obtain and install new batteries, as described on the next page.

Then you'll also need to program the DSS remote control with the correct code numbers for your specific components. See instructions starting on page 5.

ABOUT BATTERIES

NOTE: The DSS requires four (4) new “AAA” alkaline batteries (not supplied). Do not mix old and new batteries or mix alkaline with manganese-type batteries.

Installing Batteries

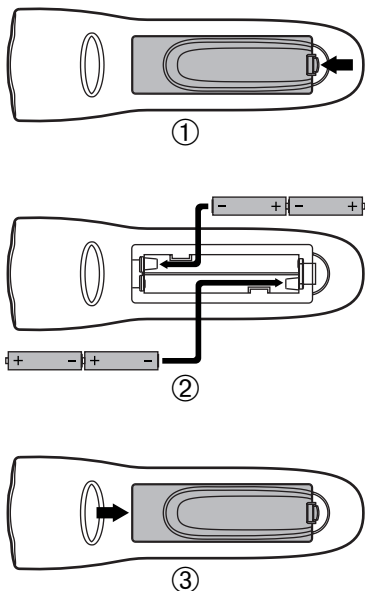

1. On the back of the remote control, push the tab and lift the battery compartment cover off.
2. Match the + and – marks on the batteries to the + and – marks in the battery case and insert four (4) “AAA” alkaline batteries.
3. Press the battery cover back into place. The tab should click when the cover is locked.

USING THE LIGHTED KEYPAD

When activated, the DSS remote control features a lighted keypad that illuminates all of the remote control keys whenever you press any key.

1.  To turn on the keypad back light, press **LIGHT** once. The keypad will remain lit for 5 seconds after you release any key.

4. Test the unit by pressing **POWER** and any Component key (e.g., **TV, VCR, CBL**, etc.). If the batteries are inserted correctly, the red indicator light will blink once.

Battery Saver

The DSS has a *Time-Out* feature that will automatically deactivate the remote control if a key is depressed for more than 30 seconds. This feature will help conserve the battery life should your remote control get stuck in a place where keys remain depressed (e.g., between the sofa cushions).

Replacement And Code Saver

When the batteries need replacing, the DSS remote control will stop working and will require four (4) new “AAA” alkaline batteries for continued operation. Simply replace the batteries, and the DSS remote control will be restored to its full functionality, complete with your favorite settings.

All of the codes and programmed information will be stored, ensuring that you will not have to reprogram the DSS remote control.

2.  To turn off the keypad back light, press **LIGHT** once again. (The keypad will not light whenever you press any key.)

PROGRAMMING YOUR REMOTE CONTROL

Philips/Magnavox Components

The DSS remote control can control up to six different components and is already *pre-programmed* for use with newer Philips/Magnavox audio/video equipment. Unless you want to change a factory setting, skip the programming instructions and simply start using your new remote control.

Programming Other Components

To control component brands other than Philips/Magnavox, you'll need to perform the following steps to manually program the DSS with codes listed under *Manufacturer's Codes* on pages 15 through 19. Or as alternative, you can use the *Auto Scan* feature, on page 6, to program your component codes.

The following chart lists the remote control's component keys and what type of device each key will control:

Key	Programmed To Control
TV	TV
VCR	VCR, DVD or LD Player
CBL	Cable Box
AUD	Amplifier, Tuner, Misc. Audio, or CD Player
DSS	Digital Satellite System
CD	CD Player, Amplifier, Tuner, or Misc. Audio

NOTE: If you want the component keys to control other types of devices, you'll need to reassign the component keys. See page 7.



IMPORTANT: Please completely read and review the following steps before proceeding. We recommend highlighting the codes (starting on page 15) for the brands you wish to program or writing them down in the supplied chart.

Setup Codes For My Components

TV	<input type="text"/> <input type="text"/> <input type="text"/> <input type="text"/>
VCR	<input type="text"/> <input type="text"/> <input type="text"/> <input type="text"/>
CBL	<input type="text"/> <input type="text"/> <input type="text"/> <input type="text"/>
DSS	<input type="text"/> <input type="text"/> <input type="text"/> <input type="text"/>
CD	<input type="text"/> <input type="text"/> <input type="text"/> <input type="text"/>
DVD	<input type="text"/> <input type="text"/> <input type="text"/> <input type="text"/>
AUDIO	<input type="text"/> <input type="text"/> <input type="text"/> <input type="text"/>
LD	<input type="text"/> <input type="text"/> <input type="text"/> <input type="text"/>
OTHER	<input type="text"/> <input type="text"/> <input type="text"/> <input type="text"/>

To Manually Program The Remote Control:

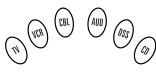
NOTE: To program a TV/VCR Combo, skip these instructions and follow the steps on the next page.

1. Manually turn on a component (e.g., TV, VCR, etc.) and, if applicable, insert media (e.g., cassette).
2.  On the remote control, press a component key once (e.g., **TV**, **VCR**, **CBL**, **AUD**, **DSS**, or **CD**).
3.  Press and hold **SET** (approx. 5 seconds) until the red light blinks twice, then release **SET**.
4. Enter the first four-digit code for your brand of component. If performed correctly, the red light will blink twice.
5.  Aim the remote control at the component and press **POWER** once. It should turn off. If it does not respond, repeat steps 2 and 3, trying each code for your brand until you find one that works. If it still does not work, try using *Auto Scan* (on page 6) to program your component.
6. Repeat steps 1 through 5 for each component you want to program into the DSS remote control.

NOTES: Press each key within 10 seconds of the previous entry. Otherwise, the remote control will exit the programming mode.

*If you press **SET** at any time (except during step 3), the remote control will exit the programming mode without saving your entries. You will have to start with step 1 to begin programming again.*

PROGRAMMING YOUR REMOTE CONTROL (continued)



Programming A TV/VCR Combo

Perform the following instructions to have the DSS control a TV/VCR Combo. For Sharp and Sony models, also see page 14.



IMPORTANT: Please completely read and review these steps before proceeding. Highlight the code (on page 17) for the brand you wish to program or write it down in the supplied chart.

Setup Code For My Component

TV/VCR



1. Manually turn on the TV/VCR Combo; insert a video cassette.
2.  On the remote control, press **VCR** once.
3.  Press and hold **SET** until the red light blinks twice, then release **SET**.
4. Use the *Setup Codes For TV/VCR Combos* (on page 17) to find the brand name. Enter the first four-digit code for your component. If performed correctly, the red light will blink twice.
5.  Aim the remote control at the TV/VCR Combo. Press **POWER** once. It should turn off. If it does not respond, repeat steps 2-3, trying each code for your brand until you find one that works. If it still doesn't work, use *Auto Scan* (later on this page) to program your TV/VCR combo.

*NOTE: If the TV/VCR Combo does not have a Power key, press **PLAY** on the DSS.*

6. If you've located a TV/VCR code that works, but it has a separate TV code, you'll also need to program it into the remote control to access volume control as follows:
 - a.  Press **TV** once. The red light will blink twice.
 - b.  Press and hold **SET** until the red light blinks twice, then release **SET**.
 - c. Enter the TV code for the TV/VCR Combo. If performed correctly, the red light will blink twice.



6. (continued)

If there is no separate TV code listed, you will need to perform the following steps to access volume control:

- a.  Press **VCR** once.
- b.  Press and hold **SET** until the red light blinks twice, then release **SET**.
- c.  Press **VOL +**.

Programming With Auto Scan

If your component does not respond to the remote control after trying all codes listed for your brand, or if your brand is not listed at all, try searching for your code using *Auto Scan*. For example, to search for a code for a TV:

1.  On the remote control, press **TV** once.
2.  Press and hold **SET** until the red light blinks twice, then release **SET**.
3.  Aim the remote control at the TV and press **SCAN**. The red light will blink twice.
4. Continue aiming the remote control at the TV (which may take up to 5 minutes) until it turns off. Immediately press any key except **VOL+**, **VOL-**, **EXIT**, **SCAN**, or **SET**.

NOTES: In the search mode, the remote will send IR (infrared) codes from its library to the selected device, starting with the most popular code first.

*If you have passed by the code that turns off the TV, press **VOL-** one or more times until the TV turns on again.*

5.  To lock in the code and exit *Auto Scan*, press and release **SET** the red light will blink twice.
6. To search for codes of other components, repeat steps 1 through 5, but substitute the appropriate key (e.g., **VCR**, **CBL**, **AUD**, **DSS**, or **CD**) for the (VCR, Cable, Audio, Satellite, or CD) component you are searching for.

PROGRAMMING YOUR REMOTE CONTROL (continued)

Checking The Auto Scan Codes

If you have set up the remote control using *Auto Scan*, you can now find out which four-digit code is operating your component:

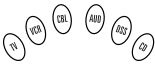
1.  On the remote control, press a component key once (e.g., **TV**, **VCR**, **CBL**, **AUD**, **DSS**, or **CD**).

2.  Press and hold **SET** until the red light blinks twice, then release **SET**.

3.  Enter **9-9-0**. The red light will blink twice.

4.  To view the code for the first digit, press **1** once. Wait 3 seconds, count the red light blinks (e.g., 3 blinks = 3) and write down the number.

NOTE: If a code digit is "0", the red light will not blink.

5.  Repeat step 4 three more times for remaining digits. Use **2** for the second digit, **3** for the third digit, and **4** for the fourth digit.

6. To find codes of other components, repeat steps 1 through 5, but substitute the appropriate key (e.g., **VCR**, **CBL**, **AUD**, **DSS**, or **CD**) for the component you are checking. As before, write down each four-digit code.

Re-Assigning Component Keys

The DSS remote can be set up to control any combination of six home entertainment components. By following these instructions, you can re-assign or duplicate a component key onto an unused component key.

1.  Press and hold **SET** until the red light blinks twice, then release **SET**.

2.  Enter **9-9-2**. The red light will blink twice.

3. Press the Component key (e.g., **TV**, **VCR**, etc.) to be moved once, then press the Component key (e.g., **AUD**, etc.) to be re-assigned once. When re-assignment is done, the red light will blink twice to confirm your choice.

4. The re-assigned key is now ready to be programmed for the new component. See *Programming Other Components* on page 5.

Example – Re-assigning The AUD Key To Be A DVD (Or VCR) Key:

For example, to have the DSS control a TV, a Cable Converter, and two VCRs, you will need to re-assign the unused **AUD** key to operate the second VCR as follows:

1.  Press and hold **SET** until the red light blinks twice, then release **SET**.

2.  Enter **9-9-2**. The red light will blink twice.

3.  Press **VCR** once.

4.  Then press **AUD** once. When re-assignment is done, the red light will blink twice to confirm your choice.

5. The **AUD** key is now ready to be programmed for your DVD (or VCR) player. See *Programming Other Components* on page 5.

OPERATING YOUR REMOTE CONTROL

The DSS Universal Remote Control is designed to be an enhanced replacement for your original remote control. Although most keys operate the same (see *Key Charts* on page 3), some do differ or provide unique features as described below.

DSS Directional Pad

The DSS remote control allows you to control the on-screen menu just like you would with your original remote control. Pressing the **MENU** key allows you to access the on-screen menu of the component you have selected (e.g. **TV**, **VCR**, **CBL**, **AUD**, **DSS**, or **CD**).

While in the menu, you can use the directional pad* to navigate and change the settings of the menu. To exit out of the Menu mode, either press the **MENU** key again or the **EXIT** key (depending on how the original remote control functioned).

NOTE: If your component's On-Screen menu requires the use of the Volume and Channel keys to navigate and change the On-Screen menu settings, you will need to use the **VOL+, **VOL-**, **CH+**, and **CH-** keys.*

GUIDE Key

The **GUIDE** key works just like the Guide key of your original remote control and allows you to access the On-Screen guide* of the component you have selected (e.g. CBL, DSS, and some newer TVs).

While in the Guide mode, the directional pad will allow you to navigate Up, Down, Left and Right just like you would with your original remote control.

To exit out of the Guide mode, either press the **GUIDE** key again or **EXIT** (depending on how the original remote control functioned) to return to normal operation.

*NOTE: *On-Screen guide is an interactive channel listings menu that is available on most DSS Satellite systems and is also used with advanced converters being offered by some cable systems. This feature is not applicable for all DSS or cable boxes.*

SELECT Key

The **SELECT** key lets you choose features displayed on the On-Screen menu and programs while in the Guide mode.







If your original remote includes a Select key, then the DSS's **SELECT** key will operate in the same manner for the selected component.

L1 ~ L3 Keys

Use the learning (**L1**, **L2**, **L3**) keys to add functions that are unique to your home entertainment components (e.g., Tracking Up or Down for a VCR).



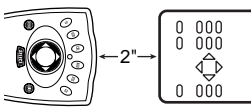

NOTE: Please have your original remote controls handy before programming learning. Be sure to press each key within 10 seconds of the previous entry. If not, the remote control will exit the programming mode.

To Program The L Keys:

1.  On the DSS remote control, press and hold **SET** until the red light blinks twice, then release **SET**.
2.  Enter **9-7-5**. The red light will blink twice.
3.  Press the component key once in which you want to learn a feature (e.g., **TV**).
4.  Press the **L** key once (e.g., **L1~L3**) in which the new feature is to be learned. The red light will blink rapidly.
5. Place your original remote control head to head (about 2" apart) from the DSS remote control.

6. On your original remote control, press and hold the key (i.e., feature) to be learned until the red light on the DSS remote control blinks twice. If the red light does not blink twice, stop and repeat steps 1 through 5.
7. To learn functions on the other **L** keys, repeat steps 3 through 6.
8.  To lock in new feature(s) on the DSS remote control, press and hold **SET** until the red light blinks twice.
9. To test a new feature, press the component key that was learned once. Then press the **L** key where the component's feature was learned.



OPERATING YOUR REMOTE CONTROL (continued)

Deleting Functions From The L Keys:

1.  On the DSS remote control, press and hold **SET** until the red light blinks twice, then release **SET**.
2.  Enter **9 - 7 - 6**.
3.  Press the component key once where the learned feature to be deleted is stored (e.g., **TV**).
4.  Press the **L** key to be deleted twice. The red light will blink twice after the second press.
5. To clear additional functions stored on the **L** keys, repeat steps 1 through 4.

SCAN Key



The **SCAN** key allows the remote control to scan the TV, VCR, CBL and DSS channels. When activated, the remote control will change channels every 3 seconds.



1.  On the remote control, press **TV**, **VCR**, **CBL**, or **DSS** once.
2.  Press **SCAN** once. Scanning will start with the current channel, then proceed to the next channel up, and continue until all channels of your TV, VCR, CBL or DSS component are scanned.
3.  To stop scanning channels, press **SCAN**.

MCP Key





The DSS remote control includes a multi-component power (**MCP**) key that can be programmed for master power on/off control of components using a single key.

To program the MCP key:

1.  On the remote control, press and hold **SET** until the red light blinks twice, then release **SET**.
2.  Enter **9 - 9 - 5**. The red light will blink twice.
3.  Press **MCP** once.

4.  Press a Component key once (e.g., **TV**, **VCR**, **CBL**, **AUD**, **DSS**, or **CD**).
5.  Press **POWER**.
6. Repeat steps 4 and 5 for each component you want under master power on/off control.
7.  Press and hold **SET** until the red light blinks twice, then release **SET**.

To Clear The MCP Key:

1.  On the remote control, press and hold **SET** until the red light blinks twice, then release **SET**.
2.  Enter **9 - 9 - 5**. The red light will blink twice.
3.  Press **MCP** once.
4.  Press and hold **SET** until the red light blinks twice, then release **SET**.

FC1 And FC2 Keys

The **FC1** and **FC2** keys can be setup to perform a number of functions with a single key press once the selection is programmed. Repetitive, time-consuming operations can be grouped for easy, convenient access through the press of one key.

The **FC** keys are ideal for home theater operations, setting a favorite channel, adding to multiple component uses, guide steps or other multiple functions you would like to control with one key press. On one key, you can define and program a sequence of events.

Moreover, each **FC** key can hold up to 15 key presses, allowing optimal individual customization. Below are a few examples to get you started.

Programming A Favorite Channel

With so many channels available through your cable system or satellite provider, a favorite channel can be programmed for easy, direct channel selection with one key press.







For example, let's assume your favorite programs are on channel 71. Use the following instructions to program the **FC1** or **FC2** key for this channel:

continued on next page...

OPERATING YOUR REMOTE CONTROL

FC1 And FC2 Keys











Programming A Favorite Channel (cont.)

1.  On the remote control, press and hold **SET** until the red light blinks twice, then release **SET**.
2.  Enter **9-9-5**. The red light will blink twice.
3.  Press and release either **FC1** or **FC2**.
4.  On the remote control, press **TV**, **VCR**, **CBL**, or **DSS** once.
5.  Enter **7-1**.
NOTE: If you have access to over 100 channels, enter in 071.
6.  Press and hold **SET** until the red light blinks twice, then release **SET**.

Programming A Secondary MCP Key With Instant Channel Selection

Just like the **MCP** key, the **FC1** and **FC2** keys can be programmed to turn on and off your equipment. For instance, let's say you want your child to be able to easily turn on the equipment and select their favorite channel.

You can setup a sequence on the **FC1** or **FC2** key to turn on the TV and cable box, and then tune the cable box to a specific channel (e.g., 11) with the push of one key.

1.  On the remote control, press and hold **SET** until the red light blinks twice, then release **SET**.
2.  Enter **9-9-5**. The red light will blink twice.
3.  Press and release either **FC1** or **FC2**.
4. Enter the following sequence:
 **CBL**,
 **POWER**,
 **TV**,
 **POWER**,
 **CBL**, and
 **1-1** (or **0-1-1** if you have access to over 100 channels)
5.  Press and hold **SET** until the red light blinks twice, then release **SET**.

Now when you press the programmed **FC** key, the Cable box and TV will turn on and the Cable box will tune to channel 11.

ABOUT OTHER FEATURES



Volume Lock

The DSS remote control is set at the factory to control the volume independently while in the TV, VCR, DSS, CBL, AUD, and CD modes.

To control the volume from one mode (e.g., TV) while in another mode (e.g., CBL, DSS, or VCR*), perform the instructions below to lock the volume setting. This procedure will not affect separate control of your audio component's volume in the AUD and CD modes*.

NOTE: By pressing **AUD or **CD** before entering the sequence below, the DSS remote control will operate your stereo and home theater volume controls in all modes.*

Example – To Set Volume Lock To TV Mode:

1.  On the remote control, press **TV** once.
2.  Press and hold **SET** until the red light blinks twice, then release **SET**.
3.  Press **VOL+**. The red light will blink twice.

Punch Through

The VCR Transport Keys (i.e., **REW**, **PLAY**, **FFWD**, **REC**, **STOP**, and **PAUSE**) are set at the factory to control the VCR, even if **TV**, **CBL**, or **DSS** is the selected mode. In other words, VCR control “punches through” regardless of what mode is on. Moreover, you do not have to press VCR before pressing the mode key.

However, if **AUD** or **CD** is the selected mode, the VCR Transport Keys will not control the VCR unless you press **VCR** first. In these two modes, the VCR Transport Keys will operate the functions for the selected component.

QUICK FEATURES SETUP GUIDE

This guide is provided here for your convenience as a quick reference for performing remote control sequences.

If you need more details, reread the full instructions presented in earlier pages.

Component Setup

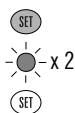
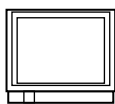

Turn on component (e.g., TV).

Press component key once (e.g., TV).

Press SET until Red Light blinks twice; release SET.

Enter 4-digit code for your brand; Red Light blinks twice after last #.

Press POWER once; if no response, repeat steps with next code.

①

②

③

④

⑤

Auto Scan

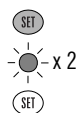
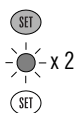
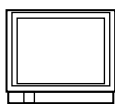

Turn on component (e.g., TV).

Press component key once (e.g., TV).

Press SET until Red Light blinks twice; release SET.

Aim remote control at component; press SCAN once. When off, press any key* to stop.

Press SET until Red Light blinks twice; release SET to lock code.

* NOTE: Not VOL+, VOL-, EXIT, SCAN, or SET.

①

②

③

④

⑤

Code Verification

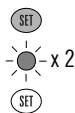
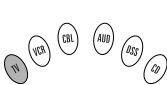

Press component key once (e.g., TV).

Press SET until Red Light blinks twice; release SET.

Enter 9-9-0; the Red Light will blink twice.

Press 1 once for 1st digit. Wait 3 sec. and count blinks. Number of blinks equals value of code digit. Repeat with 2, 3, and 4.

①

②

③

④

Volume Lock

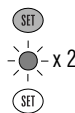
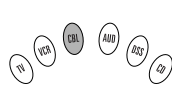

Press component* key once (e.g., CBL).

Press SET until Red Light blinks twice; release SET.

Press VOL+ once. Volume now controlled through component selected in step 1.

* NOTE: Component must have volume capabilities.

①

②

③

QUICK FEATURES SETUP GUIDE (continued)

Device Re-Assignment (e.g., AUD Key Becomes Secondary VCR Key)

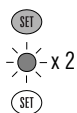

Press SET until Red Light blinks twice; release SET.

①



Enter 9-9-2; the Red Light will blink twice.

②



Press component key to be moved once (e.g., VCR).

③



Press component key to be reassigned once (e.g., AUD). Red Light will blink twice. Reassigned key is now ready for programming.

④

Programming The FC Keys (See Page 9 For Further Instructions)

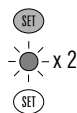

Press SET until Red Light blinks twice; release SET.

①



Enter 9-9-5; the Red Light will blink twice.

②



Press FC1 or FC2 once.

③

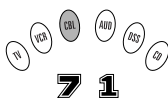

Press component key that controls channels once (e.g., CBL). Then enter channel # (e.g. 7-1)*.

④

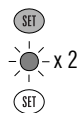

Press SET until Red Light blinks twice; release SET.

⑤

* NOTE: If over 100 channels, enter 0-7-1.

Programming The L1~L3 Keys (See Page 8 For Further Instructions)

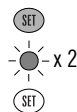

Press SET until Red Light blinks twice; release SET.

①

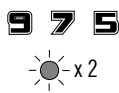

Enter 9-7-5; the Red Light will blink twice.

②



Press component key once (e.g., TV).

③

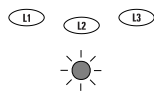

Press an L key once where new feature is to be learned; the Red Light will blink rapidly.

④

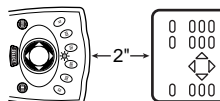

Place remote controls 2" apart; on original one, press and hold key to be learned until Red Light on DSS unit blinks twice.

⑤

To learn functions onto other L keys (or if Red Light does not blink twice in step 5), repeat steps 1~5.

⑥

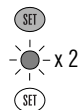

To lock in new feature, press SET until Red Light blinks twice; then release SET.

⑦

TROUBLESHOOTING

- PROBLEM:** Red Indicator Light does not blink when you press a key.
- SOLUTION:** Replace the batteries with four (4) new “AAA” alkaline batteries (see page 4).
-
- PROBLEM:** The **VOL+**, **VOL-**, and **MUTE** keys are not functional.
- SOLUTION:** Make sure that volume control is locked to a component that has volume capabilities and is programmed into the DSS remote control.
-
- PROBLEM:** The DSS remote control will not learn a function properly from your original remote control.
- SOLUTION:** Make sure the IR LED from your original remote control is lined up with the IR LED on the DSS remote control (see step 5 on page 8). If your original remote control has a lens covering the IR LED, try moving the original remote to the left or right, until the DSS remote control picks up the signal.
-
- PROBLEM:** Red Indicator Light blinks when you press a key, but home entertainment component does not respond.
- SOLUTION:** Make sure you are aiming the DSS remote control at your home entertainment component and that you are within 15 feet of the component you are trying to control.
-
- PROBLEM:** The remote control does not control home entertainment components or commands are not working properly.
- SOLUTION:** Try all listed codes for the component brand being set up. Make sure all components can be operated with an infrared remote control.
-
- PROBLEM:** TV/VCR combo does not respond properly.
- SOLUTION:** Use the VCR codes for your brand. Some combo units may require both a TV code and a VCR code for full operation (see page 6).
-
- PROBLEM:** **CH+**, **CH-**, and **LAST** do not work for your RCA TV.
- SOLUTION:** Due to an RCA design (1983-1987), only the original remote control will operate these functions.
-
- PROBLEM:** Changing channels does not work properly.
- SOLUTION:** If original remote control required pressing **ENTER** to change channels, press **ENTER** on the DSS remote control after entering a channel number.
-
- PROBLEM:** Tried *Auto Scan* and still could not find a working code.
- SOLUTION:** Try *Auto Scan* again after clearing out the component key as follows: Press and hold **ENTER** until Red Light blinks twice, then release. Next enter **9 - 9 - 2**. Then press and release the component key to be cleared twice.
-
- PROBLEM:** Remote control does not turn on Sony or Sharp TV/VCR Combo.
- SOLUTION:** For power on, these products require programming TV codes into the DSS remote control. For Sony, use TV code 0029 and VCR code 0061. For Sharp, use TV code 0112 and VCR code 0077.
-

MANUFACTURER'S CODES

Setup Codes For TVs:

AOC	0048, 0059, 0214
Admiral	0122, 0492
Aiko	0121
Akai	0059
Alaron	0208
Ambassador	0206
America Action	0209
Ampro	0780
Anam	0209
Anam National	0084
Audiovox	0121, 0209, 0480, 0652
Baysonic	0209
Belcor	0048
Bell & Howell	0045, 0183
Bradford	0209
Brockwood	0048
Broksonic	0265, 0492
CXC	0209
Candle	0059, 0085
Carnivale	0059
Carver	0083
Celebrity	0029
Cineral	0121, 0480
Citizen	0059, 0068, 0085, 0089, 0121, 0309
Clairtone	0214
Concerto	0085
Contec	0209, 0214
Craig	0209
Crosley	0083
Crown	0068, 0209
Curtis Mathes	0045, 0059, 0068, 0076, 0080, 0083, 0085, 0089, 0122, 0174, 0183, 0195, 0480, 0495, 1176, 1376
Daewoo	0048, 0068, 0121, 0480, 0652, 0653
Daytron	0048
Denon	0174
Dumont	0046, 0048
Dwin	0749, 0803
Electroband	0029, 0214
Emerson	0048, 0068, 0183, 0206, 0207, 0208, 0209, 0214, 0265, 0309, 0311, 0492, 0652, 0653
Envision	0059
Fisher	0183, 0188
Fujitsu	0208
Funai	0200, 0208, 0209
Futuretech	0209
GE	0050, 0076, 0080, 0084, 0122, 0164, 0207, 0311, 0480, 1176, 1376
Gibraltar	0046, 0048, 0059
GoldStar	0048, 0059, 0085, 0207
Gradiente	0082, 0085
Grunpy	0208, 0209
Hallmark	0207
Harley Davidson	0208
Harman/Kardon	0083
Harvard	0209
Hitachi	0085, 0174, 0180
Infinity	0083
Inteq	0046
JBL	0083
JCB	0029
JVC	0082
KEC	0209
KTV	0059, 0068, 0209, 0214, 0309
Kenwood	0048, 0059
LG	0085
LXI	0076, 0083, 0183, 0185, 0207
Logik	0045
Luxman	0085
MEI	0214
MGA	0048, 0059, 0179, 0207
MTC	0048, 0059, 0085, 0089, 0214
Magnavox	0049, 0059, 0083, 0125, 0208, 0216
Majestic	0045
Marantz	0059, 0083
Matsushita	0279
Megatron	0174, 0207
Memorex	0045, 0085, 0179, 0183, 0207, 0279, 0492
Midland	0046, 0068, 0076, 0080, 0164
Minutz	0050
Mitsubishi	0048, 0122, 0179, 0207
Motorola	0084, 0122
Multitech	0209
NAD	0185, 0195, 0207
NEC	0048, 0059, 0085
NTC	0121
Nikko	0059, 0121, 0207
Noshi	0047
Onwa	0209
Optimus	0183, 0195, 0279
Optonica	0122, 0194
Orion	0208, 0265, 0492
Panasonic	0080, 0084, 0279
Penney	0047, 0048, 0050, 0059, 0068, 0076, 0080, 0085, 0089, 0164, 0185, 0207, 1376
Philco	0048, 0049, 0059, 0083, 0125, 0174, 0492
Philips	0083
Pilot	0048, 0059, 0068
Pioneer	0195
Portland	0048, 0068, 0121
Prism	0080
Proscan	0076
Proton	0207, 0495
Pulsar	0046, 0048
Quasar	0080, 0084, 0194, 0279
RCA	0047, 0048, 0076, 0080, 0119, 0122, 0164, 1076, 1176, 1276, 1376, 1476
Radio Shack	0048, 0059, 0068, 0076, 0085, 0183, 0194, 0207, 0209
Realistic	0048, 0059, 0068, 0085, 0183, 0194, 0207, 0209
Rhapsody	0214
Runco	0046, 0059, 0632
SSS	0048, 0209
Sampo	0059, 0068
Samsung	0048, 0059, 0085, 0089, 0207
Samsux	0068
Sansei	0480
Sansui	0492
Sanyo	0183, 0188
Scimitsu	0048
Scotch	0207
Scott	0048, 0207, 0208, 0209, 0265
Sears	0076, 0083, 0085, 0183, 0185, 0188, 0200, 0207, 0208
Semivox	0209
Semp	0185
Sharp	0068, 0122, 0194
Shogun	0048
Signature	0045
Simpson	0216
Sony	0029
Soundesign	0207, 0208, 0209
Squareview	0200
Starlite	0209
Supreme	0029
Sylvania	0049, 0059, 0083, 0125
Symphonic	0200
TMK	0085, 0206, 0207
Tandy	0122

continued next page...

MANUFACTURER'S CODES

Setup Codes For TVs (cont.):

Tatung	0084
Technics	0080,0279
Technol Ace	0208
Techwood	0080,0085
Teknika	0045,0048,0068,0083,0085,0089, 0121,0179,0208,0209
Telefunken	0085
Toshiba	0089,0183,0185
Tosonic	0214
Totevision	0068
Vector Research	0059
Victor	0082
Vidikron	0083
Vidtech	0048,0207
Wards	0045,0048,0049,0050,0059,0083, 0085,0125,0194,0207,0208
White Westinghouse	0492,0652,0653
Yamaha	0048,0059
Zenith	0045,0046,0121,0492

Setup Codes For VCRs:

Admiral	0077,0238
Adventura	0029
Aiko	0307
Aiwa	0029,0066,0336
Akai	0070,0090,0135
America Action	0307
American High	0064
Asha	0269
Audiovox	0066
Beaumarck	0269
Bell & Howell	0133
Brocksonic	0238
Broksonic	0031,0150,0213,0238,0508
CCE	0101,0307
Calix	0066
Canon	0064
Capehart	0049
Carver	0110
Cineral	0307
Citizen	0066,0307
Colt	0101
Craig	0066,0076,0101,0269,0300
Curtis Mathes	0064,0070,0089,0191
Cybernex	0269
Daewoo	0049,0074,0307,0590
Daytron	0049
Denon	0071
Dynatech	0029
Electrohome	0066
Electrophonic	0066
Emerex	0061
Emerson	0029,0031,0066,0072,0090,0150, 0213,0237,0238,0241,0307,0508, 0590
Fisher	0076,0083,0133
Fuji	0062,0064
Funai	0029
GE	0064,0077,0089,0231,0269
Garrard	0029
Go Video	0461,0555
GoldStar	0066,0067
Gradiente	0029,0037
HI-Q	0076
Harley Davidson	0029
Harman/Kardon	0067,0110
Harwood	0101
Headquarter	0075
Hitachi	0029,0070,0071,0134

Hughes Network Sys.	0071
JVC	0037,0070,0096
Jensen	0070
KEC	0066,0307
KLH	0101
Kenwood	0067,0070,0096
Kodak	0064,0066
LXI	0066
Lloyd's	0029,0237
Logik	0101
MEI	0064
MGA	0072,0090,0269
MGN Technology	0269
MTC	0029,0269
Magnasonic	0307
Magnavox	0029,0064,0068,0110,0178,0592
Magnin	0269
Marantz	0064,0110
Marta	0066
Matsushita	0064,0191,0483
Memorex	0029,0064,0066,0068,0075,0076, 0077,0133,0238,0269,0336,1066, 1191,1291
Minolta	0071,0134
Mitsubishi	0072,0077,0090,0096
Motorola	0064,0077
Multitech	0029,0101
NEC	0067,0070,0096,0133
Nikko	0066
Nikon	0063
Noblex	0269
Olympus	0064
Optimus	0066,0077,0133,0191,0461,0483, 1077,1091,1191,1291
Optonica	0091
Orion	0031,0213,0238,0508
Panasonic	0064,0191,0254,0483,1191
Penney	0064,0066,0067,0071,0083,0269
Pentax	0071,0134
Philco	0064,0238,0508
Philips	0064,0091,0110
Pilot	0066
Pioneer	0096
Portland	0049
Profitronic	0269
Proscan	0089,0231
Protec	0101
Pulsar	0068
Quarter	0075
Quartz	0075
Quasar	0064,0191,0483,1191
RCA	0064,0071,0077,0089,0134,0135, 0178,0231,0269
Radio Shack	0029,1066
Radix	0066
Randex	0066
Realistic	0029,0064,0066,0075,0076,0077, 0091,0133
Ricoh	0063
Runco	0068
STS	0071
Samsung	0074,0269
Sanky	0068,0077
Sansui	0029,0070,0096,0238,0300,0508
Sanyo	0075,0076,0133,0269
Scott	0072,0074,0150,0213,0241
Sears	0029,0064,0066,0071,0075,0076, 0083,0133,0134
Semp	0074
Sharp	0077,0091
Shintom	0101
Shogun	0269
Singer	0101
Sony	0029,0061,0062,0063,0064

MANUFACTURER'S CODES

Setup Codes For VCRs (cont.):

Sylvania	0029, 0064, 0072, 0110
Symphonic	0029
TMK	0237, 0269
Tatung	0070
Teac	0029, 0070
Technics	0064, 0191
Teknika	0029, 0064, 0066
Thomas	0029
Toshiba	0072, 0074, 0241
Totevision	0066, 0269
Unitech	0269
Vector	0074
Vector Research	0067
Video Concepts	0074, 0090
Videoconic	0269
Wards	0029, 0064, 0071, 0076, 0077, 0089, 0091, 0101, 0110, 0178, 0241, 0269
White Westinghouse	0238, 0307
XR-1000	0029, 0064, 0101
Yamaha	0067
Zenith	0029, 0062, 0063, 0068, 0238, 0508

Setup Codes For TV/VCR Combos:

American High	0064 (for TV use 0080)
Brocksonic	0031, 0323
Colt	0101
Curtis Mathis	0064 (for TV use 0080)
Daewoo	0307
Emerson	0031, 0323, 0508
Funai	0029
GE	0064 (for TV use 0080), 0089 (for TV use 0076), 0077 (for TV use 0122), 0269
Hitachi	0064 (for TV use 0080), 0029
HQ	0029
Lloyds	0029
MGA	0269
Magnavox	0110 (for TV use 0083), 0064 (for TV use 0080), 0029
Magnin	0269
Memorex	0066, 0191 (for TV use 0279)
Mitsubishi	0077 (for TV use 0122)
Orion	0031, 0323, 0508
Panasonic	0064 (for TV use 0080), 0191 (for TV use 0279)
Penney	0064 (for TV use 0080), 0269, 0191 (for TV use 0279)
Quasar	0064 (for TV use 0080), 0191 (for TV use 0279)
RCA	0089 (for TV use 0076), 0064 (for TV use 0080), 0077 (for TV use 0122)
Sansui	0029, 0508
Sanyo	0269
Sears	0029, 0066
Sharp	0077 (for TV use 0122)
Sony	0061 (for TV use 0029)
Symphonic	0029
Zenith	0029

Setup Codes For Cable Converters:

ABC	0032, 0036, 0037, 0040, 0042, 0043, 0046
Allegro	0182, 0344
Archer	0182, 0826
Bell & Howell	0043

Century	0182
Citizen	0182, 0344
Comtronics	0069
Contec	0048
Eastern	0031
Emerson	0826
Everquest	0044, 0069
Focus	0429
Garrard	0182
Gemini	0044, 0826
General Instrument	0040, 0305, 0505, 0839
GoldStar	0069, 0173
Goodmind	0826
Hamlin	0038, 0049, 0063, 0288
Hitachi	0040
Hytex	0036
Jasco	0044, 0182, 0344
Jerrold	0032, 0040, 0041, 0043, 0044, 0305, 0505, 0839
Memorex	0029
Movie Time	0092
NSC	0092
Oak	0036, 0048
Optimus	0050
Panasonic	0029, 0050, 0136
Paragon	0029
Philips	0182
Pioneer	0173, 0562
Popular Mechanics	0429
Pulsar	0029
Quasar	0029
RCA	0050
Radio Shack	0044, 0344, 0826
Recoton	0429
Regal	0049, 0288
Regency	0031
Rembrandt	0040
Runco	0029
SL Marx	0069
Samsung	0069, 0173
Scientific Atlanta	0037, 0046, 0506, 0906
Signal	0044, 0069
Signature	0040
Sprucer	0050
Starcom	0032, 0044
Stargate	0044, 0069, 0826
Starquest	0044
TV86	0092
Televiow	0069
Tocom	0041, 0042
Toshiba	0029
Tusa	0044
Unika	0182
United Artists	0036
Universal	0182, 0220
Viewstar	0092
Zenith	0029, 0554
Zentek	0429

Setup Codes For Satellite/DBS:

AlphaStar	0801
Echostar	0804
Expressvu	0804
General Instrument	0390, 0656, 0898
HTS	0804
Hitachi	0848
Hughes Network Sys.	0778
JVC	0804
Jerrold	0390, 0656
Magnavox	0751, 0753

continued on next page...

MANUFACTURER'S CODES

Setup Codes For Satellite/DBS (continued):

Memorex	0753
Next Level	0898
Panasonic	0730
Philips	0751, 0753
Primestar	0390, 0656
RCA	0172, 0421, 0595, 0884
Radio Shack	0898
Sony	0668
Star Choice	0898
Toshiba	0819
Uniden	0751, 0753
Zenith	0885

Setup Codes For CD Players:

ADC	0047
Aiwa	0153, 0186
Burmester	0449
California Audio Labs	0058
Carver	0186, 0208, 0466
DKK	0029
Denon	0032, 0873
Emerson	0334
Fisher	0203, 0208
Garrard	0422, 0449
Genexxa	0061, 0334
Harman/Kardon	0186, 0202
Hitachi	0061
JVC	0101
Kenwood	0057, 0066, 0219, 0655, 0855, 0861
Krell	0186
Kyocera	0047
LXI	0334
Linn	0186
MCS	0058
MTC	0449
Magnavox	0186, 0334
Marantz	0058, 0186, 0209
Mission	0186
NSM	0186
Nikko	0203
Onkyo	0130, 0868
Optimus	0029, 0061, 0066, 0174, 0208, 0334, 0449, 0466, 0497
Panasonic	0058, 0332, 0396
Parasound	0449
Philips	0186, 0655
Pioneer	0061, 0273, 0334, 0497
Proton	0186
QED	0186
Quasar	0058
RCA	0082, 0208, 0334, 0793
Realistic	0208, 0209, 0449
Rotel	0186, 0449
SAE	0186
STS	0047
Sansui	0186, 0334
Sanyo	0208
Scott	0334
Sears	0334
Sharp	0066, 0209, 0890
Sherwood	0209
Sony	0029, 0214, 0519, 0633, 0634
Soundesign	0174
Tascam	0449
Teac	0203, 0209, 0422, 0449
Technics	0058, 0332
Victor	0101

Wards	0082, 0186
Yamaha	0065, 0216
Yorx	0490

Setup Codes For DVD Players:

Harman/Kardon	0611
JVC	0587, 0652
Kenwood	0563
Magnavox	0532
Mitsubishi	0550
Onkyo	0532, 0656
Panasonic	0519
Philips	0532, 0568
Pioneer	0554, 0600
Proscan	0551
RCA	0551
Samsung	0602
Sony	0562
Technics	0519
Theta Digital	0600
Toshiba	0532
Yamaha	0519, 0574
Zenith	0532, 0620

Setup Codes For LD Players:

Denon	0088
Mitsubishi	0088
NAD	0088
Panasonic	0233
Pioneer	0088
Quasar	0233
Sony	0222, 0230
Technics	0233

Setup Codes For Tuners/Receivers:

ADC	0560
Aiwa	0150, 0187, 0218, 0434, 1118, 1434
Capetronic	0560
Carver	0071, 0218, 1118, 1218
Casio	0224
Clarinette	0224
Curtis Mathes	0109
Denon	0033, 1133, 1189
Fisher	0071
Garrard	0492
Harman/Kardon	0139, 0218, 0920
JBL	0139
JVC	0103
Kenwood	0056, 0071, 0215, 1056, 1342, 1598
LXI	0210
Linn	0218
Lloyd's	0224
MCS	0068
Magnavox	0218, 0224, 0420, 0560, 1118, 1218
Marantz	0068, 0218, 1118, 1218
Modulaire	0224
NAD	0349
Nakamichi	0126
Onkyo	0164
Optimus	0071, 0210, 0215, 0560, 0699, 0767, 0830, 1052
Panasonic	0068, 0338
Penney	0224
Philips	0218, 0420, 1118, 1218
Pioneer	0043, 0109, 0179, 0560, 0659, 1052
Quasar	0068

MANUFACTURER'S CODES

Setup Codes For Tuners/Receivers (continued):

RCA	0083, 0560
Realistic	0210, 0224
Sansui	0218, 1118
Sanyo	0830
Sharp	0215
Sherwood	0520, 0531
Sony	0187, 0503, 1087, 1187, 1287
Soundesign	0699
Teac	0492
Technics	0068, 0338, 1337, 1338, 1547
Thorens	1218
Victor	0103
Wards	0043, 0083, 0109, 0187, 0218
Yamaha	0205, 0215
Yorx	0224
Zenith	0886

Setup Codes For DBS Audio:

Aiwa	0039, 0188
JVC	0102
Jerrold	0488, 0549
Scientific Atlanta	0489
Sony	0039, 0188
Starcom	0488

Setup Codes For Audio Amplifiers:

Aiwa	0435
Carver	0298
Curtis Mathes	0329
Denon	0189
GE	0107
Harman/Kardon	0921
JVC	0360
Linn	0298
Magnavox	0298
Marantz	0298
Optimus	0424
Panasonic	0337
Philips	0298, 0921
Pioneer	0042, 0329
Realistic	0424
Sony	0249, 0718
Soundesign	0107
Technics	0337
Victor	0360
Wards	0042, 0107
Yamaha	0383